

SBS® Connectors - up to 110 amps

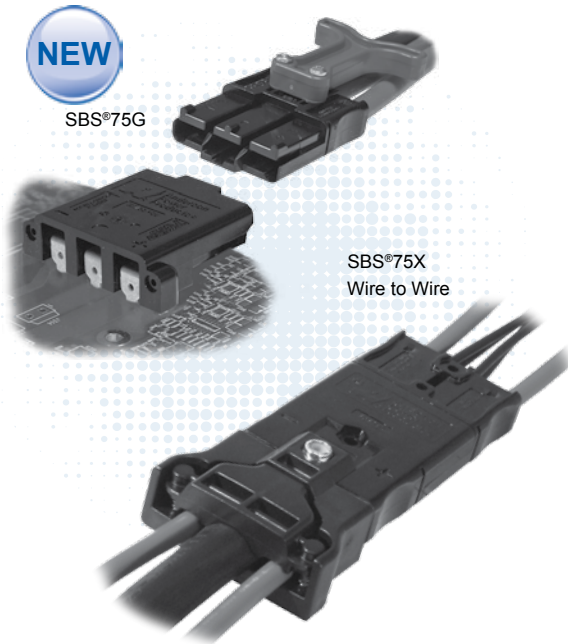

The patented SBS® connector family is designed to provide high power in a compact ergonomic housing with protection against accidental contact with live circuits. This is of particular importance in applications where DC voltages exceed 30 volts and can be health threatening.

Wire-to-wire and wire-to-board configurations both provide power contacts rated up to 110 amps. The SBS®75X offers up to 4 mate-last break-first auxiliary power / signal contacts rated up to 20 amps. The SBS®75G features a third first-mate last-break ground or power contact. All contact positions are rated for circuit interruption (hot plugging).

- **Touch Safe Interface**
 - Can safely be used in through panel applications
 - Minimizes potential contact with live circuits per IEC 60950
- **Wire-to-Wire and Wire-to-Board Configurations**
 - Allows one connector to meet multiple needs
- **Ground or Auxiliary Contacts Integrated into the One Piece Housing**
 - Meets all connection requirements in one compact connector housing

SBS® ORDERING INFORMATION |

SBS®50 Standard Housings

Polycarbonate housings feature 2 positions all finger proof. Genderless design mates with itself. Mechanical keys are color coded.

| Description | Voltage Code | Part Numbers | |
|-------------|--------------|--------------|----------|
| | | 500 | 50 |
| Red | 24V | SBS50RED-BK | SBS50RED |
| Gray | 36V | SBS50GRA-BK | SBS50GRA |
| Blue | 48V | SBS50BLU-BK | SBS50BLU |
| Green | 72V | SBS50GRN-BK | SBS50GRN |
| Black | 80V | SBS50BLK-BK | SBS50BLK |
| Brown | 96V | SBS50BRN-BK | SBS50BRN |
| White | 192V | SBS50WHT-BK | SBS50WHT |

SBS®50 Chemical Resistant (CR) Housings

Same features as the standard housings, but molded out of a chemical resistant PBT/ PC blend. Suitable for use to -40°C.

| Description | Voltage Code | Part Numbers | |
|-------------|--------------|--------------|-----------|
| | | 500 | 50 |
| Red | 24V | PSBS50RED-BK | PSBS50RED |
| Gray | 36V | PSBS50GRA-BK | PSBS50GRA |
| Blue | 48V | PSBS50BLU-BK | PSBS50BLU |
| Green | 72V | PSBS50GRN-BK | PSBS50GRN |
| Black | 80V | PSBS50BLK-BK | PSBS50BLK |
| Brown | 96V | PSBS50BRN-BK | PSBS50BRN |

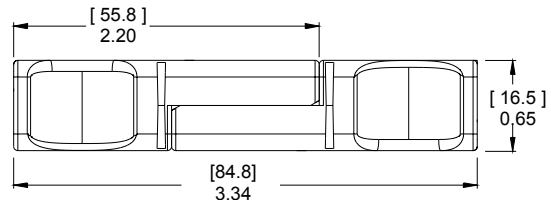
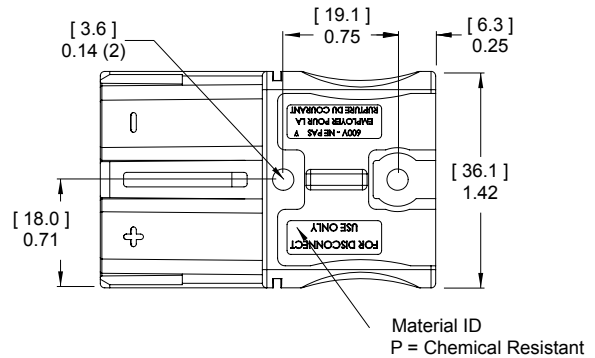

SBS®75X Standard Housings

Polycarbonate housings feature 4 auxiliary and 2 primary positions all finger proof. Genderless design mates with itself, or the PCB connector. Mechanical keys are color coded.

| Voltage | | | |
|------------------|-------|--------------|-----------|
| Color | | | |
| Description | Code | Part Numbers | |
| Minimum Quantity | | 250 | 50 |
| Black | 80V | SBS75XBLK-BK | SBS75XBLK |
| Brown | 96V | SBS75XBRN-BK | SBS75XBRN |

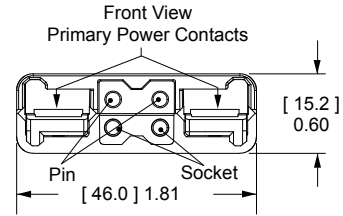

SBS®75X Chemical Resistant (CR) Housings

Same features as the standard housings, but molded out of a chemical resistant PBT/ PC blend. Suitable for use to -40°C.

| Voltage | | | |
|------------------|-------|---------------|------------|
| Color | | | |
| Description | Code | Part Numbers | |
| Minimum Quantity | | 250 | 50 |
| Green | 72V | PSBS75XGRN-BK | PSBS75XGRN |
| Black | 80V | PSBS75XBLK-BK | PSBS75XBLK |

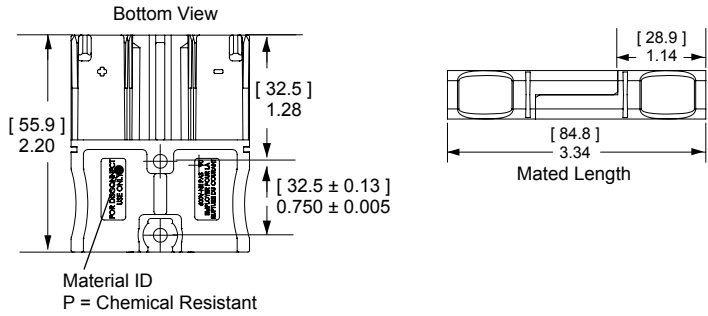

SBS®75X Assembled PCB Connector

Fully assembled PCB connector is designed to mate with SBS®75X Wire connector. All positions are preloaded with contacts including standard mating length auxiliary positions. Press fit board locks help secure the connector to the PCB before and after soldering.

| Voltage | | | |
|------------------|-------|----------------|-------|
| Color | | | |
| Description | Code | Part Number | |
| Minimum Quantity | | 100 | |
| Black | 80V | SBS75XPRBLK-BK | |

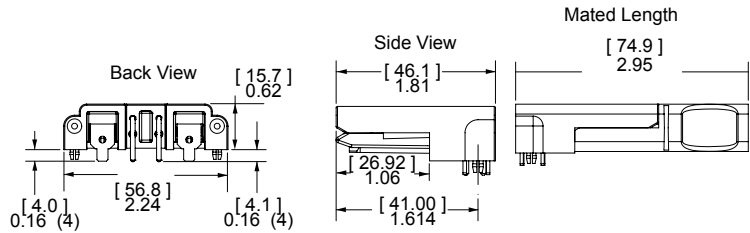

See PCB connector drawing on website for further detail.



SBS®75G Wire Housings

Polycarbonate housings feature three finger proof positions. The center position can be used for pre-mate power or ground. Genderless design mates with itself, or the PCB connector. Mechanical keys are color coded. Inquire with customer service for chemical resistant housings.

| Voltage | | | |
|------------------|-------|--------------|-----------|
| Color | | | |
| Description | Code | Part Numbers | |
| Minimum Quantity | | 250 | 50 |
| Blue | 48V | SBS75GBLU-BK | SBS75GBLU |
| Black | 80V | SBS75GBLK-BK | SBS75GBLK |
| Brown | 96V | SBS75GBRN-BK | SBS75GBRN |
| White | 192V | SBS75GWHT-BK | SBS75GWHT |

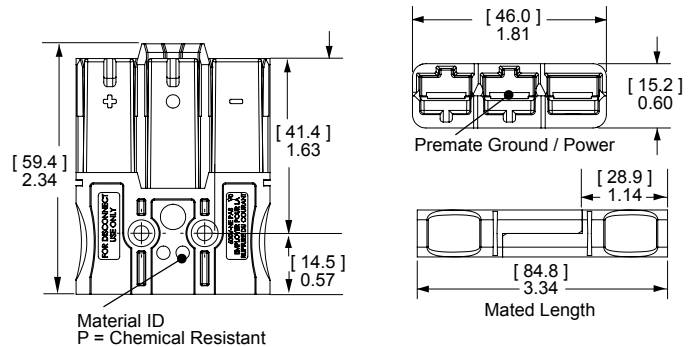

SBS®75G Assembled PCB Connector

Fully assembled PCB connector is designed to mate with SBS®75G Wire connector. Has press fit board locks to help secure the connector to the PCB before and after soldering.

| Voltage | | | |
|------------------|-------|----------------|-------|
| Color | | | |
| Description | Code | Part Number | |
| Minimum Quantity | | 100 | |
| Black | 80V | SBS75GPRBLK-BK | |

See PCB connector drawing on website for further detail.

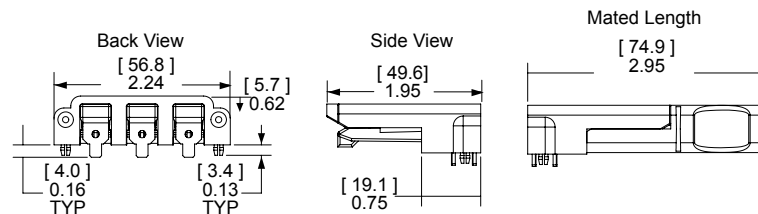

SBS® Silver Plated Primary Power Wire Contacts

Use two silver plated contacts per housing for the best electrical performance and durability up to 10,000 mating cycles. Standard contacts are for use in all primary power positions for SBS® 50, 75X, & 75G wire housings. See reducing bushings in accessory section for smaller wires. See reducing bushings in accessory section for smaller wires.

| Type | AWG | mm ² | Loose Piece | | Dimensions | |
|------------------|----------|-----------------|--------------|--------------|------------|-----------|
| | | | Part Numbers | Part Numbers | - A - | inches mm |
| Minimum Quantity | | | 1,000 | 100 | | |
| Standard | 6 | 16 | 1339G2-BK | 1339G2* | 0.22 | 5.59 |
| Standard | 8 | 10 | 1339G5-BK | 1339G5* | 0.19 | 4.83 |
| Standard | 12 to 10 | 2.5 to 6 | 1339G3-BK | 1339G3* | 0.14 | 3.56 |

* Are sold as pairs. 2 contacts ship for every 1 ordered.

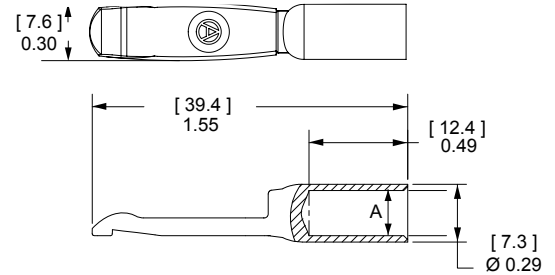

NEW SBS®75G Silver Plated Pre-Mate Wire Contacts

Pre-Mate contacts are for the center Pre-Mate position on the SBS®75G wire housings. See reducing bushings in accessory section for smaller wires.

| Type | AWG | mm ² | Loose Piece | | Dimensions | |
|------------------|----------|-----------------|--------------|--------------|------------|-----------|
| | | | Part Numbers | Part Numbers | - A - | inches mm |
| Minimum Quantity | | | 500 | 50 | | |
| Pre-Mate | 6 | 16 | 1340G1-BK | 1340G1 | 0.22 | 5.59 |
| Pre-Mate | 8 | 10 | 1340G2-BK | 1340G2 | 0.19 | 4.83 |
| Pre-Mate | 12 to 10 | 2.5 to 6 | 1340G3-BK | 1340G3 | 0.14 | 3.56 |

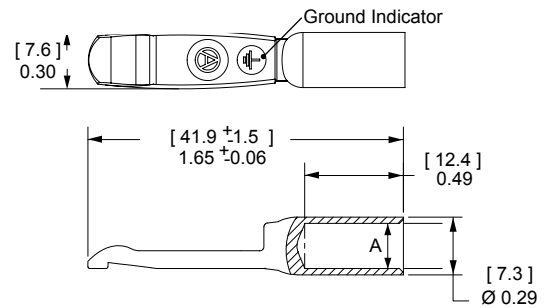

Pin Contacts for SBS®75x Auxiliary

Gold plated contacts are available in 3 lengths to allow sequencing of circuits.

| Description | AWG | mm ² | Part Numbers | |
|-----------------------|----------|-----------------|--------------|-----------------|
| | | | 500 | 50 |
| Minimum Quantity | | | 500 | 50 |
| Standard Length 7.7mm | 12 | 2.5 | PM16P12S30 | PM16P12S30-50 |
| | 16 to 14 | 1.0 to 1.5 | PM16P1416S30 | PM16P1416S30-50 |
| | 20 to 16 | 0.75 to 1.0 | PM16P1620S30 | PM16P1620S30-50 |
| | 24 to 20 | 0.50 to 0.75 | PM16P2024S30 | PM16P2024S30-50 |
| Pre-Mate 9.3mm | 12 | 2.5 | PM16P12A30 | PM16P12A30-50 |
| | 16 to 14 | 1.0 to 1.5 | PM16P1416A30 | PM16P1416A30-50 |
| | 20 to 16 | 0.75 to 1.0 | PM16P1620A30 | PM16P1620A30-50 |
| | 24 to 20 | 0.50 to 0.75 | PM16P2024A30 | PM16P2024A30-50 |
| Post-Mate 6.4mm | 12 | 2.5 | PM16P12C30 | PM16P12C30-50 |
| | 16 to 14 | 1.0 to 1.5 | PM16P1416C30 | PM16P1416C30-50 |
| | 20 to 16 | 0.75 to 1.0 | PM16P1620C30 | PM16P1620C30-50 |
| | 24 to 20 | 0.50 to 0.75 | PM16P2024C30 | PM16P2024C30-50 |

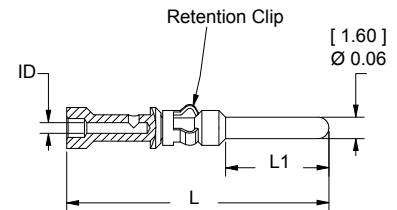

| Auxiliary Pin Contact Lengths | - L - | | - L1 - | |
|-------------------------------|-------|------|--------|-----|
| | in. | mm | in. | mm |
| Standard Length 7.7mm | 0.77 | 19.6 | 0.30 | 7.7 |
| Pre-Mate 9.3mm | 0.83 | 21.2 | 0.37 | 9.3 |
| Post-Mate 6.4mm | 0.72 | 18.3 | 0.25 | 6.4 |

Socket Contacts for SBS®75x Auxiliary

Selectively gold plated contacts offer low resistance and durability up to 10,000 mating cycles.

| Description | AWG | mm ² | Part Numbers | |
|------------------|----------|-----------------|--------------|-----------------|
| | | | 500 | 50 |
| Minimum Quantity | | | 500 | 50 |
| Socket Contact | 12 | 2.5 | PM16S12S32 | PM16S12S32-50 |
| | 16 to 14 | 1.0 to 1.5 | PM16S1416S32 | PM16S1416S32-50 |
| | 20 to 16 | 0.75 to 1.0 | PM16S1620S32 | PM16S1620S32-50 |
| | 24 to 20 | 0.50 to 0.75 | PM16S2024S32 | PM16S2024S32-50 |

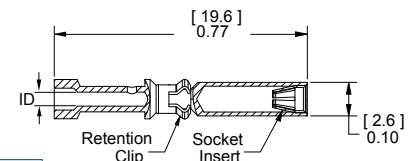

Auxiliary Socket Contacts Crimp Barrel ID

| Wire Gauge | in. | mm. |
|------------|------|-----|
| #24 / 20 | 0.04 | 1.1 |
| #20 / 16 | 0.07 | 1.7 |
| #16 / 14 | 0.08 | 2.1 |
| #12 | 0.10 | 2.6 |

SBS® CONNECTOR SPECIFICATIONS

Electrical

| Current Rating Amperes ¹ | UL 1977 | CSA/TUV |
|---|-----------|---------|
| Primary Power (6 AWG) | 110 | 75 |
| Auxiliary (12 AWG) | 20 | 10 |
| Voltage Rating AC/DC | | |
| UL 1977 | 600 | |
| Dielectric Withstanding Voltage | | |
| Volts AC | 2,200 | |
| Avg. Mated Contact Resistance Milliohms¹ | | |
| Power & Ground: 1 1/4" of #6 AWG wire | 0.200 | |
| Auxiliary: Wire & PCB | 3.000 | |
| UL Hot Plug Current Rating Amperes - 250 cycles at 120V DC | | |
| Wire & PCB Power | 50A | |
| Wire & PCB Auxiliary | 5A | |
| UL Ground Short Time Current Test - SBS75G Wire & PCB | | |
| 1530 Amps, #6 AWG Wire | 6 seconds | |

Materials

| | |
|--|---------------------------------|
| Housing | |
| Standard Plastic Resin | Polycarbonate |
| Chem. Resistant Resin | Polycarbonate / PBT blend |
| Contact Retention Spring | Stainless Steel |
| Housing Flammability Rating | |
| UL94 | V-0 |
| Wire Power & Ground Contact | Silver Plated Copper Alloy |
| PCB Power & Ground Contact | Tin Plated Copper Alloy |
| SBS75X Auxiliary Contacts | |
| Pin | Copper alloy, Au over Ni |
| Socket | BeCu, Au over Ni |
| Socket Body | Copper alloy, Sn bright over Ni |
| Retention Clip | Stainless Steel |
| PCB Press Fit Retainers | Brass - Tin Plated |
| Contact Termination Methods | |
| Crimp ³ | Wire Contacts |
| Hand Solder | Wire and PCB Contacts |
| Solder Dip | PCB Contacts |
| Wave Solder | PCB Contacts |

Auxiliary contacts are available for SBS®75X only.

SBS®75X and SBS®75G PCB connectors are designed to mate only with the wire connector of the same series.

¹ Based on: 105°C rated or better cable of the largest size, Properly calibrated APP® recommended tooling, and a 25°C ambient temperature. UL rating not to exceed the maximum operating temperature. CSA rating below a 30°C temperature rise.

² Limited by the thermal properties of the connector plastic housing.

³ Use APP® recommended tooling only. Alternate tools may adversely affect the performance of our connectors along with UL and CSA recognition.

Mechanical

| Wire Size Range | AWG | mm ² | |
|---|-----------------------|-----------------|-----------|
| Power Contacts (with bushings) | 16 to 6 | 1.3 to 13.3 | |
| Auxiliary Contacts | 24 to 12 | 0.25 to 3.3 | |
| Max. Wire Insulation Diameter | | | |
| | in. | mm | |
| SBS®75G Power & Ground | 0.380 | 9.652 | |
| SBS®50 & SBS®75X Power Contacts | 0.410 | 10.414 | |
| SBS®75X Auxiliary Contacts | 0.140 | 3.600 | |
| Operating Temperature² | | | |
| | °F | °C | |
| Standard | -4° to 221° | -20° to 105° | |
| Chemical Resistant | -40 to 221° | -40° to 105° | |
| Mating Cycles No Load by Plating | | | |
| | Silver (Ag) | Tin (Sn) | Gold (Au) |
| Power & Ground Contacts Wire | 10,000 | | |
| Power & Ground Contacts PCB | | 1,500 | |
| Auxiliary Contacts | | | 10,000 |
| Avg. Mating / Unmating Force | | | |
| | Lbf. | N | |
| SBS®75X and SBS®75G Wire to Wire | 16 | 70 | |
| SBS®50 Wire to Wire | 8 | 36 | |
| SBS®75X and SBS®75G Wire to PCB | 8 | 36 | |
| Min. Contact / Spring Retention Force | | | |
| | Lbf. | N | |
| Power, Standard Housing | 50 | 222 | |
| Power, Chem. Resistant Housing | 30 | 133 | |
| Aux. Standard Housing | 15 | 67 | |
| Aux. Chem. Resistant Housing | 10 | 44 | |
| PCB Specifications | | | |
| Mounting Style | Plated Through Hole | | |
| Max PCB Thickness- in. [mm] | 0.093 [2.4] | | |
| Recommended Traces Power & Ground | #6 AWG Cross Section | | |
| Recommended Traces Auxiliary | #12 AWG Cross Section | | |
| Min. Creepage / Clearance Distance PCB | | | |
| | in. | mm | |
| Power to Aux. Creepage SBS®75X | 0.41 | 10.4 | |
| Power to Aux. Clearance SBS®75X | 0.24 | 6.1 | |
| Power to Ground Creepage SBS®75G | 0.35 | 8.9 | |
| Power to Ground Clearance SBS®75G | 0.26 | 6.7 | |
| Auxiliary Creepage SBS®75X | 0.12 | 3.0 | |
| Auxiliary Clearance SBS®75X | 0.12 | 3.0 | |

Protection

Touch Safety with Wire Contacts & PCB Mating Interface

| | |
|-----------|------|
| IEC 60950 | Pass |
| IEC 60529 | IP20 |



| SBS® CONNECTOR TEMPERATURE CHARTS |

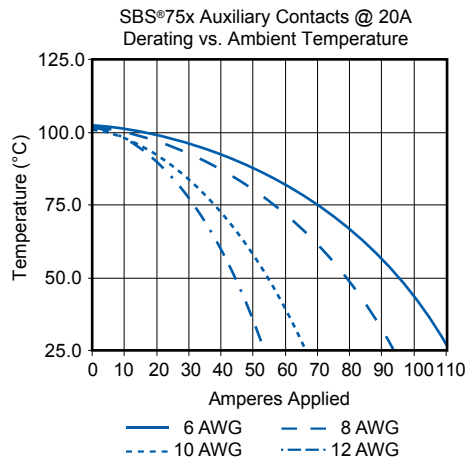
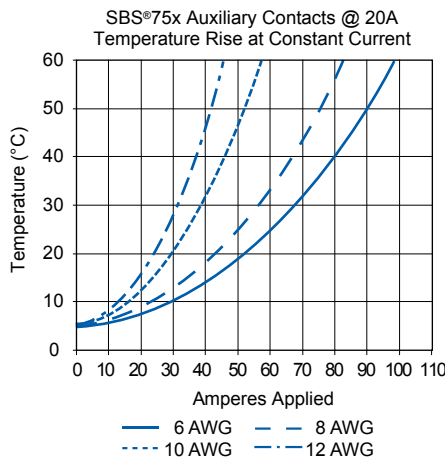
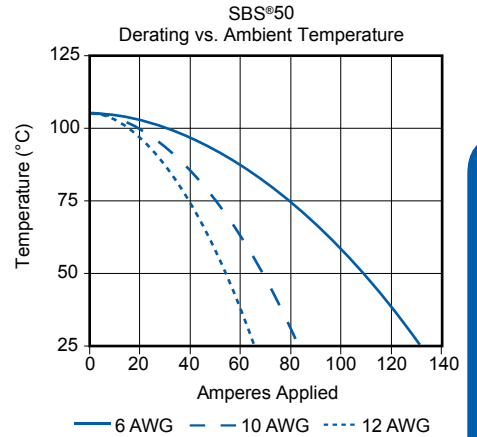
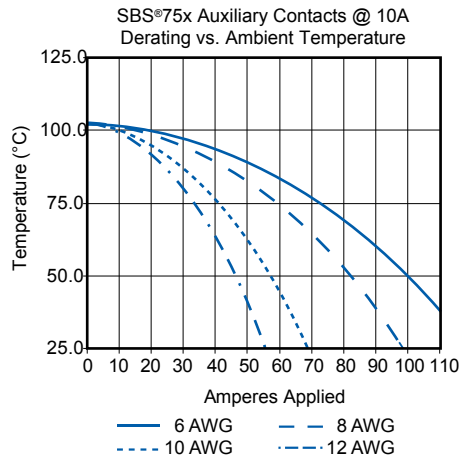
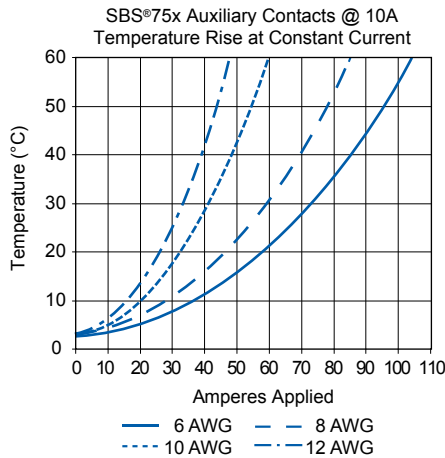
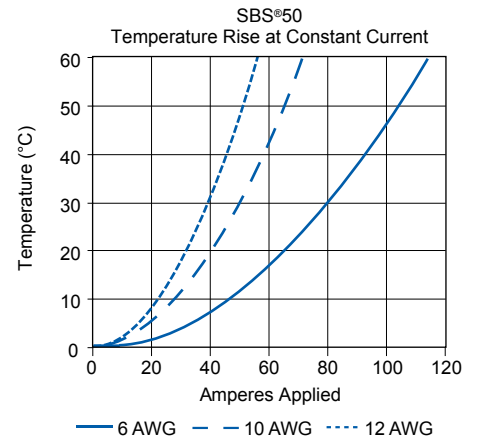
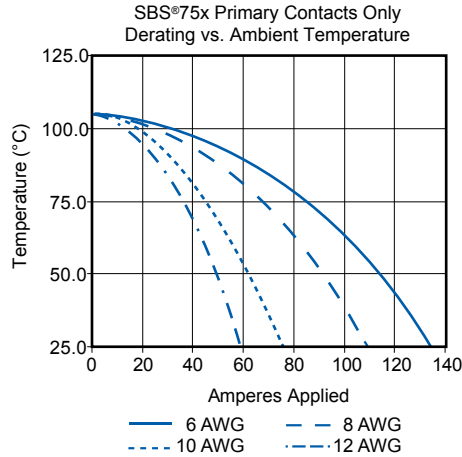
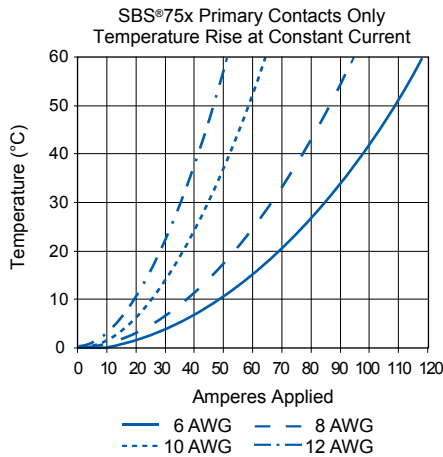

NOTE: Temperature rise charts are based on a 25°C ambient temperature.

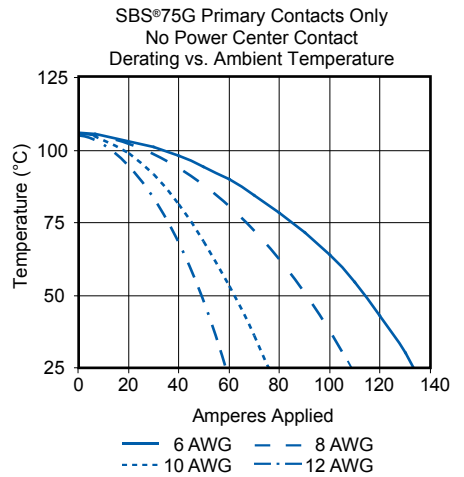
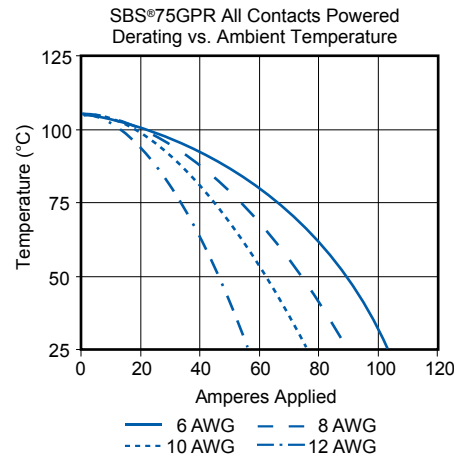
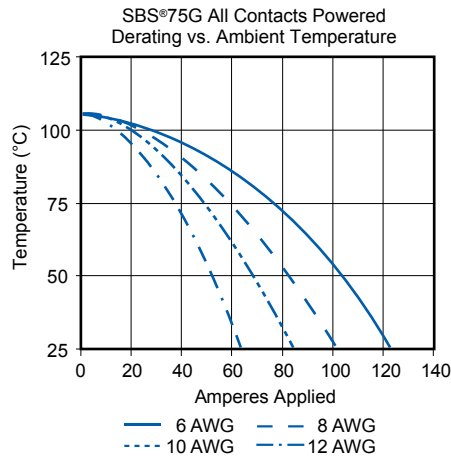
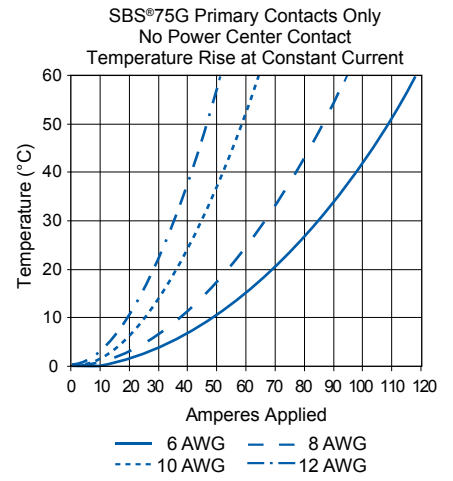
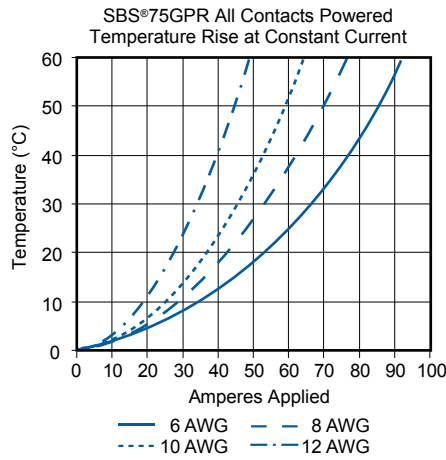
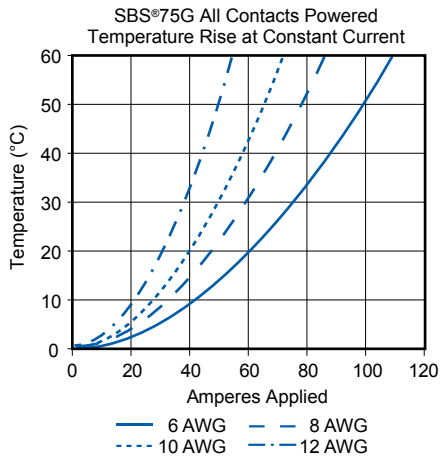

NOTE: Temperature rise charts are based on 25 °C ambient temperature.

SBS® Accessories

Mounting Clamp for SBS®50

Mounting clamps can be used for fastening a SBS®50 series housings to a panel. Fastening hardware not included.

| Description | --- Part Number --- |
|--------------------------------|---------------------|
| Minimum Quantity | 20 sets of 2 |
| Panel Mount Bracket for SBS®50 | 1466G1 |

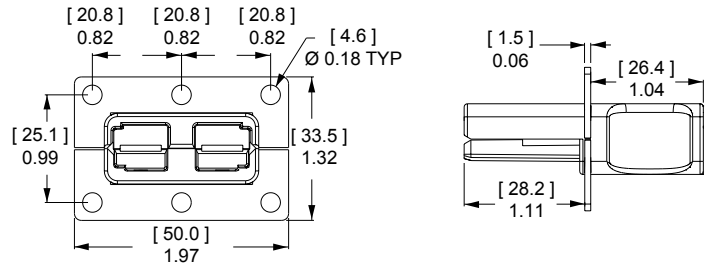

T-Handle for SBS®50 and SBS®75X

The "T" handle makes mating and unmating the connector easier. The non-conductive red plastic material is strong and safe. (2) Self tapping screws are used to secure the handle to the connector housing.

| Description | ----- Part Numbers ----- | |
|--------------------------------------|--------------------------|---------------|
| Minimum Quantity | 1,000 | 50 |
| Red "T" Handle + Hardware Bag | - | SBS50-HDL-RED |
| Hardware Bag (2 Screws) | - | 104G17 |
| Red "T" Handle Only | H13899P1 | - |
| #8 x 5/8" Screw (Order 2 Per Handle) | H1120P53 | - |

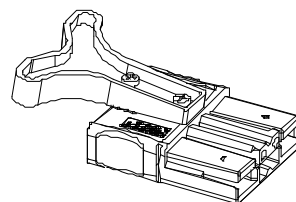

T-Handle for SBS®75G

The "T" handle makes mating and unmating the connector easier. The non-conductive red plastic material is strong and safe. (2) Machine screws and lock nuts.

| Description | - Part Number - |
|-------------------------------|-----------------|
| Minimum Quantity | 50 |
| Red "T" Handle + Hardware Bag | SBS75GHDL |

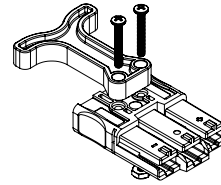

Dust Cover SBS®50

Prevents dust and dirt from entering the mating interface of the connector when unmated. NOTE: Not a Hermetic Seal.

| Description | ---- Part Number ---- |
|------------------------------------|-----------------------|
| Minimum Quantity | 500 50 |
| Dust Cover with Lanyard Strap, Red | 113890P1 134G1 |

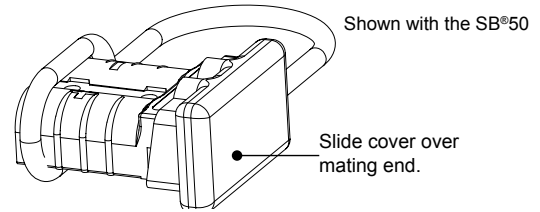

Cable Clamps for SBS®50

Durable metal cable clamps securely hold cables to prevent accidental strain or pulls from dislodging wire or contacts from the housing. Cable clamps are recommended for solder terminated wires.

| Description | Cable Size | | ----- Part Numbers ----- | |
|---------------------------------------|-------------------------|---------------------------------|--------------------------|----------|
| | AWG or (Inches O.D.) | mm ² or (mm O.D.) | 500 | 50 |
| Self Attaching for Discrete Conductor | 8 to 6 | 10 | 990-BK | 990 |
| Self Attaching for Discrete Conductor | 12 to 10 | 2.5 to 4 | 990G2-BK | 990G2 |
| Bolt On for Discrete Conductor | 12 to 6 | 2.5 to 10 | 990G1-BK | 990G1 |
| Bolt On for Bundled Conductor | (0.320 to 0.450) | (4.27 to 11.43) | 5905-BK | 5905 |

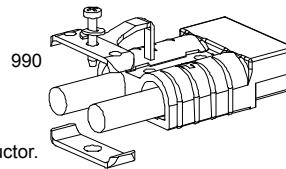
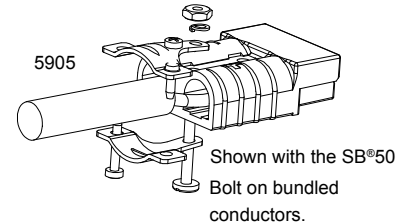

Self attaching discrete conductor.

The given wire O.D. information is an estimate. Cable clamps should be evaluated for performance with the actual wire to be used.

Cable Clamps for SBS®75X with Integral Handle

Rugged chemical resistant PBT/ PC plastic cable clamps securely hold cables to prevent accidental strain or pulls from dislodging wire or contacts from the housing. Cable clamps are recommended for solder terminated wires.

| Description | Cable Size AWG or (Inches O.D.) | mm ² or (mm O.D.) | ----- Part Numbers ----- | |
|----------------------------------|------------------------------------|---------------------------------|--------------------------|-------------|
| Minimum Quantity | | | 100 | 25 |
| Large Wire Clamp Kit w/ Hardware | 12 to 6 (0.39 to 0.60) | 4 to 10 (9.9 to 15.2) | PSBS75XCLP1-BK | PSBS75XCLP1 |
| Small Wire Clamp Kit w/ Hardware | 12 to 6 (0.34 to 0.55) | 4 to 10 (8.6 to 14.0) | PSBS75XCLP2-BK | PSBS75XCLP2 |

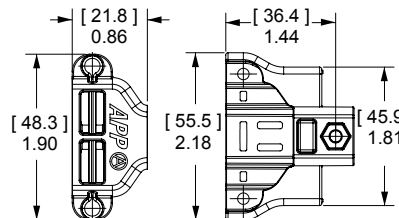

The given wire O.D. information is an estimate. Cable clamps should be evaluated for performance with the actual wire to be used.

Clamp hardware requires phillips or flat blade screwdriver to assemble.

Reducing Bushings

Use with contact part number 1339G2-BK or 1340G1-BK to allow a smaller wire to be used with the connector. Electrical capability is derated with smaller wire.

| Contact Barrel Size | Wire Size | ----- Part Numbers ----- | | | Dimensions | | | |
|--------------------------------|---|--------------------------|---------|------|---------------------|-------------------------|------|-------|
| | | | | | - ID - inches mm | - Length - inches mm | | |
| Minimum Quantity | | 3,000 | 1,000 | 100 | | | | |
| #6 AWG [13.3 mm ²] | #8 AWG [8.4 mm ²] | - | 5912-BK | 5912 | 0.18 | 4.57 | 0.45 | 11.43 |
| #6 AWG [13.3 mm ²] | #12- 10 AWG [3.3- 5.3 mm ²] | 5910-BK | - | 5910 | 0.14 | 3.56 | 0.47 | 11.94 |
| #6 AWG [13.3 mm ²] | #16- 14 AWG [1.3- 2.1 mm ²] | 5913-BK | - | 5913 | 0.09 | 2.29 | 0.47 | 11.94 |

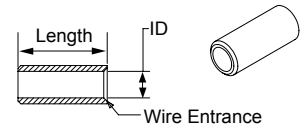

SBS® - Tooling Information

| Wire Size | | Power Contact Part Number | Pneumatic Bench Tool | + Die | + Locator | Number of Crimps | Hand Tool |
|-----------|-----------------|---------------------------|----------------------|--------|-----------|------------------|-----------|
| AWG | mm ² | | | | | | |
| #6 | 13.3 | 1339G2 | 1387G1 | 1388G6 | 1389G9 | Single | 1309G4 |
| #8 | 8.4 | 1339G5 | | 1388G7 | | | |
| #10 / 12 | 5.3 / 3.3 | 1339G3 | | 1388G6 | 1389G20 | | |
| #6 | 13.3 | 1340G1 | | | | | |
| #8 | 8.4 | 1340G2 | | | | | |
| #10 / 12 | 5.3 / 3.3 | 1340G3 | | | | | |

| Wire Size | | Auxiliary Contact Part Number | APP Hand Tool w/ Integral Locator | Mil Std. Hand Tool* M22520/1-01 | Pneumatic Tool* | Number of Crimps | Locator for: TM0001 & TP0001 |
|-----------|-----------------|-------------------------------|-----------------------------------|---------------------------------|-----------------|------------------|------------------------------|
| AWG | mm ² | | | | | | |
| #12 / 24 | 2.5 / 0.25 | All Crimp Pins | PM1000G1 | O R TM0001 | O R TP0001 | Single | + TL0001 TL0002 |
| | | All Crimp Sockets | | | | | |

* TP0001 and TM0001 tools require locators TL0001 for Pins and TL0002 for Sockets.
NOTE: See website for the most current information.